

# STM32F4 Communication board

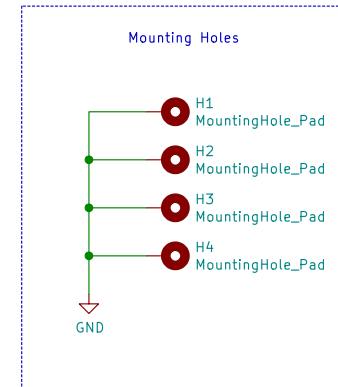
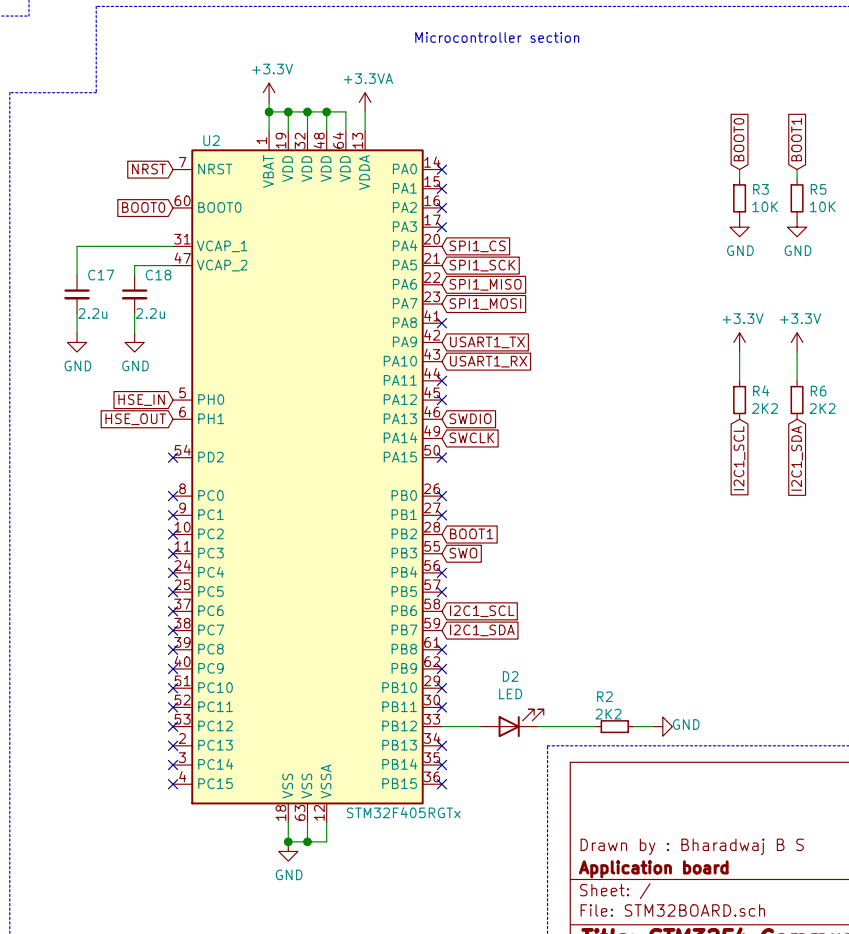
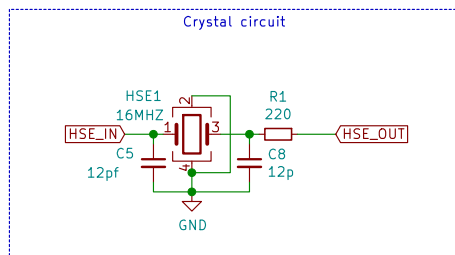
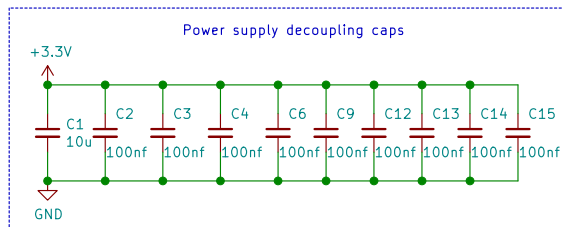
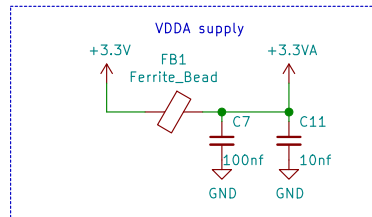
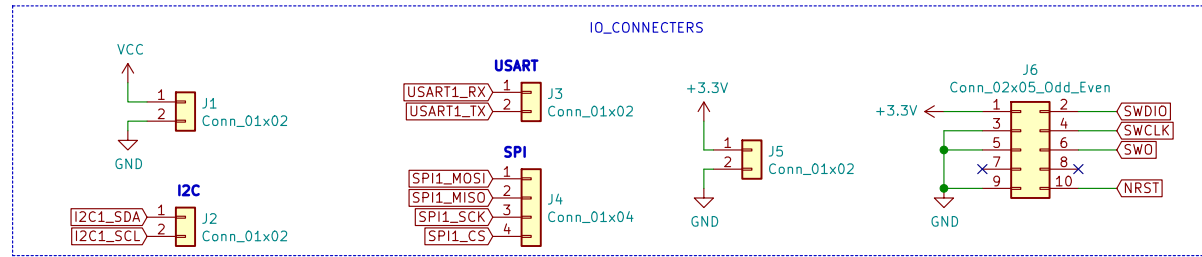
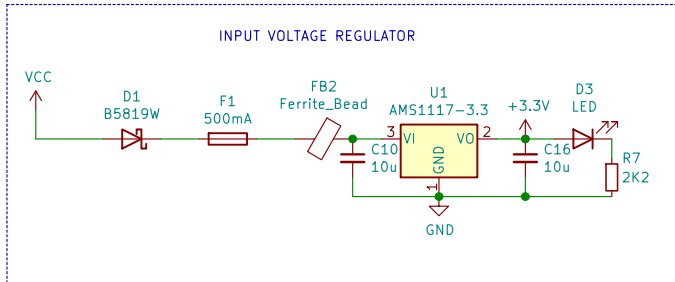

Drawn by : Bharadwaj B S  
**Application board**  
 Sheet: /  
 File: STM32BOARD.sch

**Title: STM32F4 Communication Board**

Size: A4  
 KiCad E.D.A. kicad (5.1.9)-1

Date:  
 Rev:  
 Id: 1/1